

# KAUDERNI

66 x 61 x 82 cm

D:SCHRANK FÜR AQUARIUM ENG:CABINET FOR AQUARIUM F:MEUBLE POUR AQUARIUM NL:MEUBEL VOOR AQUARIUM  
I:MOBILE PER ACQUARIO E:MUEBLE PARA ACUARIO PL:AKWARIUM CABINET RUS:Тумба для аквариума

- A - 589 x 800 cm
- B - 625 x 680 cm
- C - 625 x 589 cm
- D - 625 x 500 cm
- E - 625 x 589 cm
- F - 589 x 800 cm
- G - 330 x 800 cm
- H - 330 x 800 cm

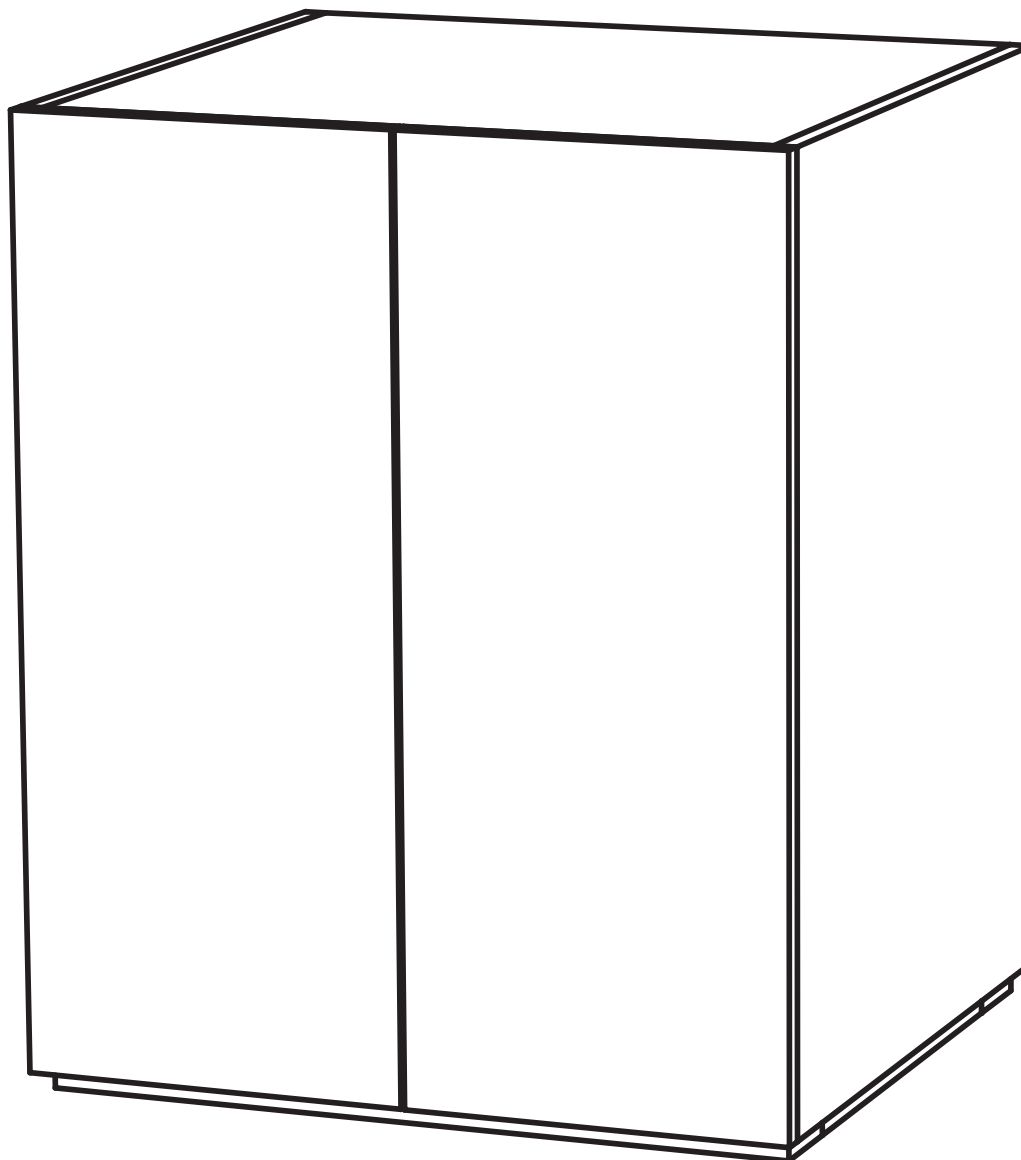

NOT included:



KIT included:



40x



8x

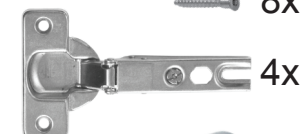

4x



2x



WHITE GLUE 3x



20 min

**AQUA MEDIC**

Bissendorf, Germany

[www.aqua-medice.de](http://www.aqua-medice.de)

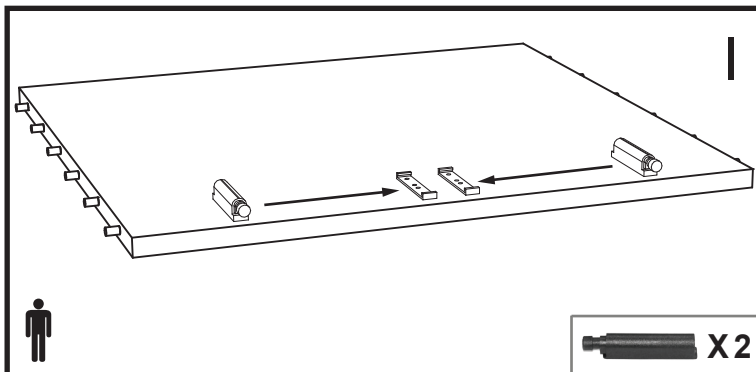

I

X2

Geben Sie etwas Klebstoff in die Bohrungen für die Holzdübel und setzen Sie dann die Dübel in die Bohrungen ein.

First put glue into the holes of the wooden dowel pins, then put the dowel pins into the holes.

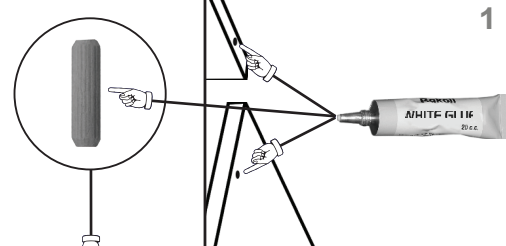

1

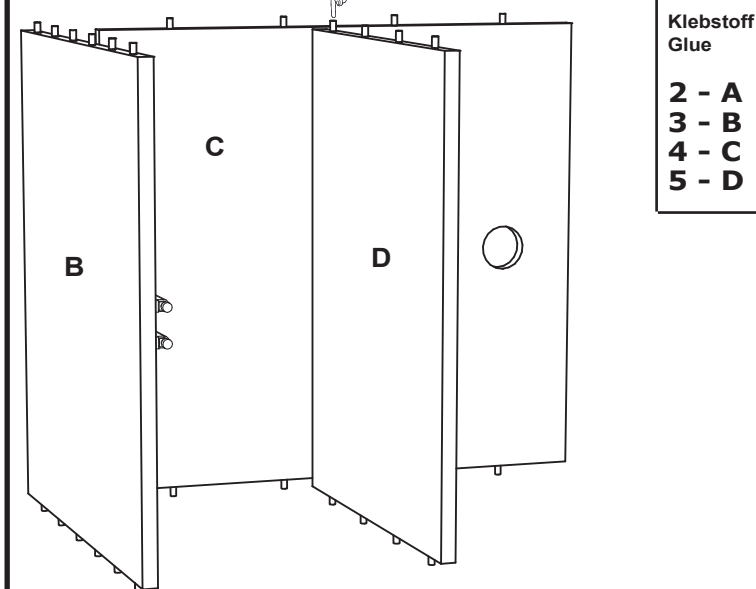

Klebstoff  
Glue

2 - A  
3 - B  
4 - C  
5 - D

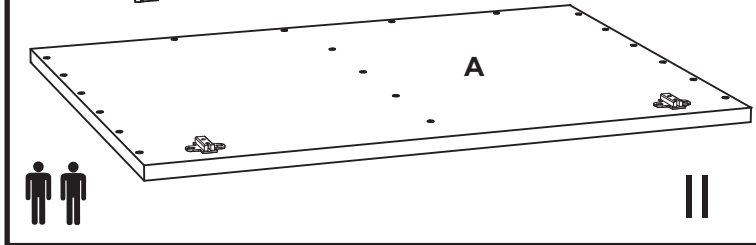

II

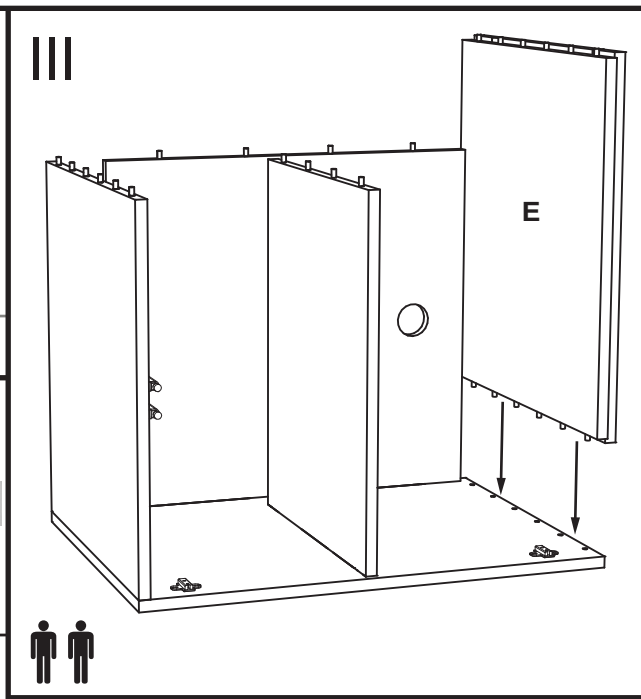

III

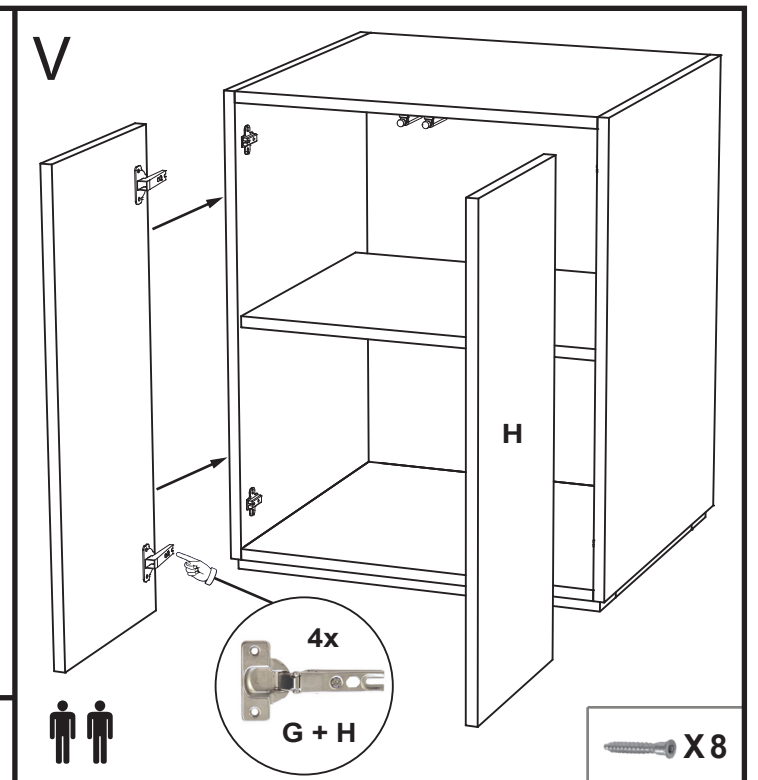

V

4x  
G + H

X8

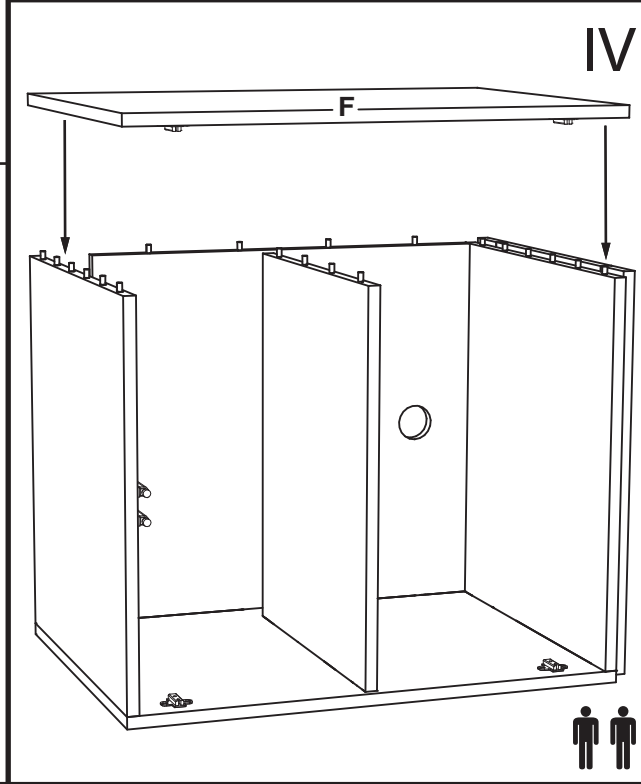

IV

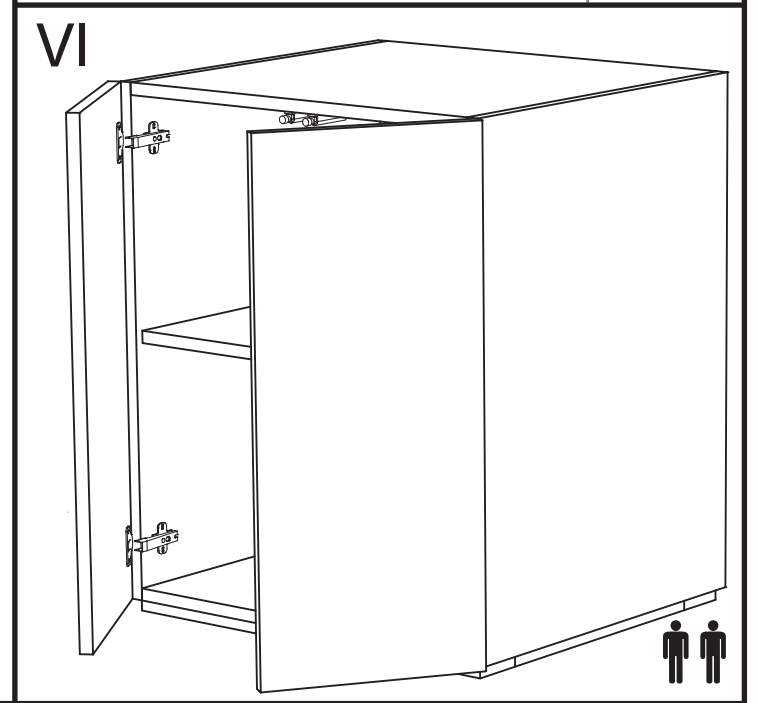

VI